

HAKI Komponentliste DK

Indhold

HAKI UNIVERSAL	3
HAKI UNIVERSAL AL	21
HAKI UNIVERSAL S6 AL	24
HAKI UNIVERSAL APPLIKATIONER	26
HAKI RAMME	34
HAKI RAMME AL	38
RØR & KOBLINGER	40
HAKITEC 450 OVERDÆKNING	41
HAKITEC 750 OVERDÆKNING	43
HAKITKS 750 OVERDÆKNING	48
HAKITEC INDDÆKNING	50
ØVRIGT SORTIMENT	52















Alm. leveringsbetingelser

Leverings- og prisvilkår:

- (a) Alt salg sker til den pris, som er gældende ved ordrens afgivelse, hvis ikke anden skriftlig aftale foreligger. For så vidt angår priser er tilbud gældende i 2 uger fra tilbudsdatoen.
- (b) Alle priser, hvad enten disse er indeholdt i prislister eller på anden måde er meddelt køber, er, medmindre andet udtrykkeligt fremgår af tilbuddet eller ordrebekræftelsen, baseret på levering af HAKI's lager, således at alle omkostninger i forbindelse med forsendelse af det købte er for købers regning. © De opgivne priser er ekskl. miljøgebyr og merværdiafgift.
- (c) Iht. p23 NL17 er garanti gældende i 2 år for bekræftede stilladsmateriel.
- (d) Iht. NL 17 I tilfælde af, at der ydes nogen form for kredit, anses salget sket med ejendomsforbehold, hvorfor ejendomsretten til det solgte forbliver hos HAKI, indtil hele købesummen, inkl. renter og eventuelle omkostninger, er fuldt erlagt.
- (e) HAKI A/S garanti omfatter ikke skader som er opstået som følge af fejlagtig brug eller montering af produktet. Haki hæfter kun for det leverede, men ikke for følgeskader, herunder driftstabt, produktskader og andre indirekte tab. Haki hæfter ikke for normalt slid eller ukyndig behandling. Indtil da er køber ikke berettiget til at sælge, pantsætte, bortgive eller på anden måde disponere over det købte.

HAKI A/S har ret til at kontrollere, at det med ejendomsforbehold solgte materiel, der stedse skal befinde sig i Danmark, stadig er i købers besiddelse.

HAKI Farvekode





564		1050		1964		2500	
700		1250		2050		2550	
770		1550		2210		3050	
1010		1655		2357			



Fodspindler

		Udfør.	Art. nr	Vægt
Fodspindler		BS		
Justerbar		G	2071000	5,0
BS=55-570 mm				
Fodspindler led- og vippebar 750		G	2071005	5,9
Justerbar bundplade 150x150 mm				
Justerbar 85-585 mm				
Låsefjeder til fodspindel		G	2071100	0,17
Holder fodspindlen på plads ved løft				
af stiladssektion				







Søjle

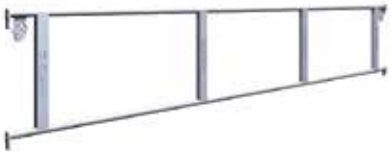
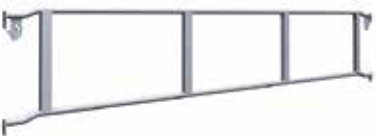

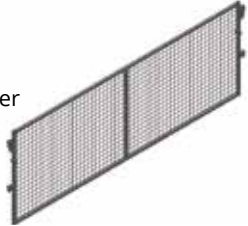
		Udfør.	Art. nr	Vægt	
Søjle S		S 500	G	7016050	2,9
Søjletop med tap Ø 38 mm		S 1000	G	7016100	5,3
Rørdiameter 48 mm		S 1500	G	7016150	7,7
		S 2000	G	7016200	10,1
		S 3000	G	7016300	15,2
TopSøjle SC		SC 353	G	7011004	2,0
Rørdiameter 48 mm		SC 853	G	7011104	4,8
		SC 1353	G	7011154	7,3
		SC 1853	G	7011204	9,8
Split til Søjletop		Snapbolt 16	G	2116000	0,17
Diameter 16 mm		Split med kæde	G	5141257	0,3
Til forstærkning af søjletop ved trækraft					
f.eks. ved hængende stillads, løfte					
eller stillads til overdækning					
Bøjle-kobling		Kpl. 48	G	2048017	1,4

Horisontaler



		Udfør.	Art. nr	Vægt	
Længdebjælke		1050	G	7021102	4,8
Med fjederlås		1250	G	7021122	6,5
Rørdiameter 34 mm		1525	G	7021151	7,0
		1550	G	7021152	6,6
		1655	G	7021162	6,7
		1964	G	7021202	8,5
		2050	G	7021192	8,5
		2500	G	7021252	10,9
		2550	G	7021257	10,8
		3050	G	7021302	12,3

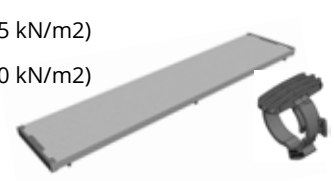

		Udfør.	Art. nr	Vægt
Enrørsbjælke	564	G	7022050	3,6
Med fjederlås	700	G	7022066	3,6
Rørdiameter 48 mm	770	G	7022073	3,6
	1010	G	7022097	4,3
	1050	G	7022101	4,4
	1250	G	7022121	5,1
	1525	G	7022151	6,2
	1550	G	7022153	6,2
	1655	G	7022161	6,3
	1964	G	7022191	7,3
	2050	G	7022201	7,8
	2500	G	7022246	9,9
	2550	G	7022253	9,7
	3050	G	7022301	11,3
<hr/>				
Rækværk		Udfør.	Art. nr	Vægt
M-hegn GFL	564	G	7052056	3,1
Med fjederlås	700	G	7052070	3,8
Rør octagon 28 mm	770	G	7052077	4,0
	1010	G	7052104	4,8
	1050	G	7052106	4,9
	1250	G	7052124	5,7
	1525	G	7052151	6,4
	1550	G	7052154	6,6
	1655	G	7052164	7,4
	1964	G	7052194	8,1
	2050	G	7052204	8,2
	2500	G	7052254	9,2
	2550	G	7052255	9,3
	3050	G	7052304	10,5
M-hegn for trætralle GFLH	700	G	7052071	3,9
Med fjederlås	770	G	7052076	4,1
Forhøjet 26 mm	1050	G	7052108	5,0
-Til søjler med lommer på samme niveau og indplankning med traller	1250	G	7052125	5,8
	1525	G	7052152	6,5
- For længdebjælker til søjler med lommer på ulige niveauer og indplankning med traller	1550	G	7052155	6,7
	1655	G	7052165	7,5
	1964	G	7052195	8,2
	2050	G	7052205	8,3
	2500	G	7052250	9,3
	2550	G	7052256	9,4
	3050	G	7052305	11,5

		Udfør.	Art. nr	Vægt
Netskærm SGF	1050	G	7055101	13,3
Trinløs justerbar 118 mm	1250	G	7055121	14,6
i højden for at	1655	G	7055161	17,0
tilpasse ulige indplankninger	1964	G	7055191	19,4
Nøglevidde 22 mm	2050	G	7055205	20,0
	2500	G	7055250	23,2
	2550	G	7055251	24,0
	3050	G	7055300	26,8
				
Stag		Udfør.	Art. nr	Vægt
Diagonalstag DS	700/770	G	7122074	8,5
Med kilekoblinger. Rørdiameter 48 mm	1250	G	7122124	9,0
DS 700/770 L=1750	1250x1500	G	7122125	7,9
DS 1250 L=1995	1655	G	7122164	10,1
DS 1655 L=2290	1655x1500	G	7122165	9,1
DS 1964 L=2520	1964	G	7122194	10,7
DS 2500 L=3022	2500	G	7121254	12,3
DS 3050 L=3498	3050	G	7121304	14,2
				
Diagonalstag udbygget for tralle	3050	G	7121301	15,5
Med kilekoblinger				
Rørdiameter 48 mm				
DS-UB 3050 L=3448				
				
Horisontalstag HDS	3050x1655	G	7141000	13,3
Med kilekoblinger	3050x1250	G	7141001	13,2
Rørdiameter 48 mm	1250x1250	G	7141010	8,5
HDS 3050x1655 L=3472	1655x1655	G	7141005	10,5
HDS 3050x1250 L=3298				
				
Forankring		Udfør.	Art. nr	Vægt
Rørfastgørelse SVF	300	G	8832031	1,36
Rørdiameter 48 mm, Krogdiameter 16 mm	450	G	8832046	2,2
Tilladt belastning 9 kN	600	G	8832061	2,6
Monteres med Kobling fast 48x48	900	G	8832091	3,7
Justerbar SVFA	1200	G	8832121	4,8
	SVFA 709-119	G	8832110	4,9
				
Vægstag VST	1000	G	7111100	5,3
Med ledbar plade	2000	G	7111200	9,1
Rørdiameter 48 mm	3000	G	7111300	13,7
Monteres med Kobling	4000	G	7111400	16,7
fast 48x48	5000	G	7111500	21,9
	6000	G	7111600	24,5
				

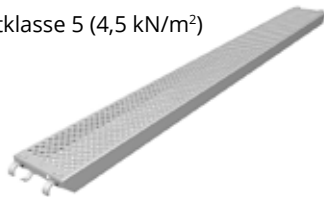
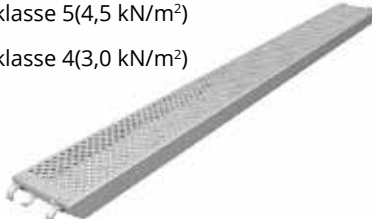





			Udfør.	Art. nr	Vikt
Tralle AL Lastklasse 6 (6,0 kN/m ²)		1250x495	AL	2021144	7,7
		1655x495	AL	2021204	10,0
Tralle Stål Lastklasse 6 (6,0 kN/m ²)		1050x495	G	2152107	10,8
		1250x495	G	2152124	12,5
		1655x495	G	2152164	15,0
Tralle Ergo Træ	2021141 - Lastklasse 5 (4,5 kN/m ²)	1400x490x56		2021141	10,0
	2021221 - Lastklasse 4 (3,0 kN/m ²)	2200x490x56		2021221	15,8
	Låsejern t/tralle kort			7161002	0,6
	Låsejern t/tralle lang			7161009	0,6
Tralle Komposit	2170 - Lastklasse 5 (4,5 kN/m ²)	2170x490		2021402	12,5
	1950 - Lastklasse 4 (3,0 kN/m ²)	1950x490		2021409	11,5
	Trallelås Komposit			2021410	0,03
Alu-Tralle Lastklasse 4 (3,0 kN/m ²)		2200x495x55		4021222	12,2
Krogdæk B=400 mm	Med glasfiber plade	1050	AL	4073108	6,2
		1250	AL	4073124	7,5
	Lastklasse 3 (3,0 kN/m ²)	1655	AL	4073164	9,1
	Med lås i hver ende	2050	AL	4073204	10,7
		2500	AL	4073254	12,9
		3050	AL	4073304	15,2
Krogdæk B=600 mm	Med glasfiber plade	1050	AL	4071118	7,4
		1250	AL	4071128	9,1
	Lastklasse 3 (3,0 kN/m ²)	1655	AL	4071168	11,1
	Med lås i hver ende	2050	AL	4071208	12,9
		2500	AL	4071268	15,8
		3050	AL	4071308	18,5

		Udfør.	Art. nr	Vægt
Krogdæk med låge B=600 mm	1655	AL	4071169	13,2
Med glasfiber plade	2050	AL	4071209	15,0
Lastklasse 3 (3,0 kN/m ²)	2500	AL	4071269	17,0
Med lås i hver ende	3050	AL	4071309	19,6
				
Alu-lejder St	2100	AL	2091210	3,4
Til opgangsdæk				
				
Krogdæk med låge og Stige				
Med glasfiber plade	3050x600	AL	4071315	19,5
Lastklasse 3 (3,0 kN/m ²)	2500x600	AL	4071310	24,5
Med lås i hver ende				
				
AL planke B=200x90 mm	770	AL	2153079	3,6
Med vridlås i hver ende	1050	AL	2153105	4,5
L=770-2500 - Lastklasse 6 (6,0 kN/m ²)	1250	AL	2153125	5,0
L=3050 - Lastklasse 5 (4,5 kN/m ²)	1655	AL	2153165	6,2
	1964	AL	2153195	7,1
	1655	AL	2158160	6,9
	2500	AL	2153255	8,7
	3050	AL	2153305	10,3
AL planke B=230x90 mm	564	AL	2158056	3,5
Med vridlås i hver ende	700	AL	2158070	3,7
L=564-2500 - Lastklasse 6 (6,0 kN/m ²)	770	AL	2158077	4,1
L=3050 - Lastklasse 5 (4,5 kN/m ²)	1010	AL	2158100	4,9
	1050	AL	2158105	4,9
	1250	AL	2158120	5,6
	1550	AL	2158150	6,5
	1655	AL	2158160	6,9
	1964	AL	2158190	7,8
	2050	AL	2158205	8,1
	2500	AL	2158250	9,5
	2550	AL	2158255	9,7
	3050	AL	2158300	11,2

		Udfør.	Art. nr	Vægt
AL planke B=295x90 mm	770	AL	2153078	4,4
Med vridlås i hver ende	1050	AL	2153104	5,4
L= 564-1964 - Lastklasse 6 (6,0 kN/m ²)	1250	AL	2153124	6,1
L=2500-3050 - Lastklasse 5 (4,5 kN/m ²)	1655	AL	2153164	7,5
	1964	AL	2153194	8,6
	2500	AL	2153254	6,9
	3050	AL	2153304	12,4
AL planke B=320x90 mm	770	AL	2153078	4,4
Med vridlås i hver ende	1050	AL	2153104	5,4
L= 770-1964 - Lastklasse 6 (6,0 kN/m ²)	1250	AL	2153124	6,1
L=2500 - Lastklasse 5(4,5 kN/m ²)	1655	AL	2153164	7,5
L=3050 - Lastklasse 4(3,0 kN/m ²)	1964	AL	2153194	8,6
	2500	AL	2153254	6,9
	3050	AL	2153304	12,4
HAKI Stålblank B=200 mm	564	G	21510564	4,2
L= 564-2500 - Lastklasse 6 (6,0 kN/m ²)	700	G	21510700	4,6
L= 2550-3050 - Lastklasse 5 (4,5 kN/m ²)	770	G	21510770	5,0
	1010	G	21511010	6,5
	1050	G	21511050	6,8
	1250	G	21511250	7,4
	1655	G	21511655	9,5
	1964	G	21511964	11,1
	2050	G	21512050	11,5
	2500	G	21512500	13,8
	2550	G	21512550	14,3
	3050	G	21513050	17,0
HAKI Stålblank B=230 mm	564	G	21520564	4,2
L= 564-2500 - Lastklasse 6 (6,0 kN/m ²)	700	G	21520700	5,1
L= 2550-3050 - Lastklasse 5 (4,5 kN/m ²)	770	G	21520770	5,3
	1010	G	21521010	6,6
	1050	G	21521050	6,9
	1250	G	21521250	7,6
	1655	G	21521655	9,7
	1964	G	21521964	11,8
	2050	G	21522050	12,2
	2500	G	21522500	14,6
	2550	G	21522550	15,2
	3050	G	21523050	17,7

		Udfør.	Art. nr	Vægt
Kombi fodbræt				
Træ, gul				
FL 3000x150x32 For Fodlistebeslag 2131001	Fodliste FL 3000x150x32		2025300	5,8
FL 3300x150x32 (Kantbrædt 3,0m)	Fodliste hak FL 3300x150x32		2025331	5,6
For Fodlistebeslag 7161006, 4161010, 7161010 eller 2131003				
				
Fodliste				
Aluminium				
	Teleskopisk 1200-1964	AL	2026020	5,0
	Teleskopisk 1900-3050	AL	2026021	7,3
	564	AL	4161051	1,0
	700	AL	4161071	1,3
	770	AL	4161077	1,4
	1010	AL	4161101	1,8
	1050	AL	4161105	1,9
	1250	AL	4161121	2,2
	1550	AL	4161151	2,8
	1655	AL	4161161	2,9
	1964	AL	4161191	3,5
	2050	AL	4161201	3,6
	2210	AL	4161221	4,0
	2357	AL	4161231	4,2
	2500	AL	4161251	4,6
	2550	AL	4161255	4,6
3050	AL	4161301	5,5	
Fodlistebeslag				
Med kilkobling				
	LF 70	G	7161006	1,0
	LF 70 kort	G	7161012	0,7
	FLT 70 T/FS Søjle	G	7161000	0,6
	LFT 70 T/S Søjle	G	7161010	0,9
Fodlistebeslag AL				
LFT 70 til fodliste 2025331 og trætrall	LFT 70	AL	4161010	0,2
Fodlistebeslag				
Plast				
			2131001	0,2
Til hjørneløsninger				
		G	2131002	0,7
Fjederstål				
Til Kombi fodbrædt			2131003	0,1

			Udfør.	Art. nr	Vægt
Konsol uden søjletop Rørdiameter 48 mm Med fjederlås		SK 230	G	7211025	1,6
		SK 300	G	7211033	2,0
		SK 334	G	7211035	2,0
		SK 400	G	7211041	2,1
		SK 460	G	7211045	2,3
		SK 600	G	7211061	2,7
		SK 600 Forstærket	G	7211062	4,5
Konsol med søjletop Rørdiameter 48 mm Med fjederlås Rørdiameter 48 mm Med fjederlås		SK 564	G	7211051	5,8
		SK 700	G	7211067	5,9
		SK 770	G	7211071	6,5
Konsol justerbar Justerbar 460 - 690 mm Lastklasse 3 (2,0 kN/m ²) OBS! Får ej Monteres i HAKI Universal AL Søjle		SK 460-690	G	7211069	4,1
Konsoldiagonal Kombineres med Enrørsbjælke 1250 eller Længdebjælke 1250		SKD 1250	G	7212001	11,1
Konsol Nøglevidde 22 mm Konsol indvendig hjørne Kombineres med konsol SK 460		SKH 460	G	7211046	6,7
Hjørne Konsol		564x564		4011020	4,5
		770x770		4011021	7,3
		1250x1250		4011022	14,5

		Udfør.	Art. nr	Vægt
Portdrager	500/6100	G	7031602	59,1
				
750 Stål-drage				
Låses med 6 stk. Ø16 snapbolt 2116000	Snapbolt 16	G	2116000	0,1
	1000	G	7031100	14,4
	2000	G	7031200	26,8
	3000	G	7031300	38,8
Adapter 750 Stål-drage		G	7203007	6,0
Låses med 12 stk. Ø16 snapbolt 2116000				
750 Alu-drage				
L=1250, 2250, 3250 resp. 6250 mm	Alu-drager 750/1250	AL	4032125	9,4
Alu-drage samles med 2 stk. 7203001	Alu-drager 750/2250	AL	4032225	16,6
Samlepind og	Alu-drager 750/3250	AL	4032325	23,9
8 stk. Snapbolt og	Alu-drager 750/6250	AL	4032625	46,0
12 mm pr. samling				
	Samlepind 750	G	7203001	2,0
	Snapbolt 12	G	2113100	0,1
				
Kobling 750				
For special profil	vert. 48	G	2048007	1,8
på drager 750 AL	hor.48	G	2048008	1,8
				

		Udfør.	Art. nr	Vægt
450 Alu-drager m. bøjler	Snapbolt 12	G	2113100	0,1
L=2220, 4100, 6100 resp. 8100 mm	Alu-drager FB 2220	AL	4032211	9,9
Med bøjler vertikalt og hul i det øverste rør	Alu-drager FB 4100	AL	4032411	17,8
til kedergaffel	Alu-drager FB 6100	AL	4032611	25,8
Alu-drager samles med 2 stk. 7203000	Alu-drager FB 8100	AL	4032811	34,0
Samlepinde og 8 stk. snapbolte 12 mm	Samlepind	G	7203000	2,0
pr. samling				

450 Alu-drager

L= 4100, 6100 resp. 8100 mm

Alu-drager samles med 2 stk. 7203000

Samlepind og g 8 stk. Snapbolt

12 mm pr. samling



Alu-drager FB 4100	AL	4032410	16,7
Alu-drager FB 6100	AL	4032610	24,3
Alu-drager FB 8100	AL	4032810	32,3







Samlepind	G	7203000	2,0
Snapbolt 12	G	2113100	0,1









Adapter Alu-drager









750	G	7203337	6,9
450	G	7203338	5,8

Adapter stilbar







750	G	7203339	21,0
-----	---	----------------	------







		Udfør.	Art. nr	Vægt
UTV Trappe AL Med hvileplan og lås Bredde 600 mm		UTV Gelænder 2500x2000	AL 4058245	9,2
		UTV Gelænder 3050x2000	AL 4058300	10,3
		UTV Trappe 2500x2000	AL 4102247	22,9
		UTV Trappe 3050x2000	AL 4102302	29,2
		UTV Trappe 1655x1000	AL 4102165	13,0
		Beslag LSS-UTV	G 7058300	1,5
Gelænderstolpe LSS 1000 Til Trappe UTV AL		G	7015102	4,2
UTV Gelænder indiv. Bredde 600 mm Til Trappe UTV AL		3050 til alu	G 7058253	11,4
		2500 til alu	G 7058256	10,4
		3050x1500	G 7058259	10,1
UTV Trappe AL Med hvileplan og lås Bredde 600 mm		UTV 500	AL 4102050	5,5
		UTV 1000	AL 4102100	9,0
		UTV 1500	AL 4102150	11,3
Adgangstrin		700/770	G 7103065	7,8
		1250	G 7103120	11,1
		1655	G 7103160	14,7
StV Stige med hvileplan Med hvileplan og lås LxH 1250x2000 mm alt. 1655x2000 mm Bredde 475 mm		STV 1250	G 7083202	12,5
		STV 1655	G 7083203	17,1





			Udfør.	Art. nr	Vægt
SS Ophængningsbeslag Gridgulv			G	7171001	2,4
Tilladt belastning 20,0 kN					
SS Ophængningsbeslag H-profil		150-300	G	7172000	6,8
Tilladt belastning 20,0 kN		300-450	G	7172001	7,6
Til H-rofil med flange bredde 150-300 mm,		80-180	G	7172100	5,1
300-450 mm resp. 80-180 mm					
Tilladt belastning 20,0 kN					
SS Ophængningsbeslag L-profil			G	7176000	5,3
Tilladt belastning 20,0 kN					
Til L-profil med flange bredde 60-120 mm					
SS Ophængningsbeslag Kæder		1362	G	7175001	4,3
Tilladt belastning 20,0 kN		850	G	7175002	3,0
Byggehøjde 1362 resp. 850 mm		2000	G	7175004	4,8
SS Ophængningsbeslag KF 48 dobbelt			G	7175101	2,1
Hul diameter 20 mm					
Nøglevidde 22 mm					
Tilladt belastning 20,0 kN					
SS Ophængningsbeslag Bulb			G	7177001	2,5
Til bulbplade 200x10/300x13mm/			G	7177005	2,5
160x9/200x12mm			G	7177003	3,7
320x11,5/370x16mm					
Tilladt belastning 20,0kN					
Til bulbplade 160x8mm			G	7177000	1,6
Tilladt belastning 12,0kN					
Kan modificeres for andre dimensioner					
SS Ophængningsbeslag Bulb-rør			G	7177100	5,5
Til bulbplade 160x8mm					
Tilladt belastning 12,0kN					
Kan modificeres for andre dimensioner					
SS Klemmeslag			G	7215032	5,5
Nøglevidde 30 mm		500			
Monteres på pladekant, tykkelse 15-35 mm					





			Udfør.	Art. nr	Vægt
Højdeindstillingssøjle			G	7202001	6,5
Rækværkssøjle		S 1000 21	G	7015009	6,1
Til montage mellem		S 1000 22	G	7015010	6,1
to længdebjælker		S 1500 21	G	7015011	8,8
Nøglevidde 21 mm resp. 22 mm		S 1500 22	G	7015012	8,8
		S 2000 21	G	7015007	12,5
		S 2000 22	G	7015008	12,5
Understøtningsbjælke		564	G	7204050	3,6
		700	G	7204070	4,1
		770	G	7204071	4,3
		1050	G	7204101	5,5
		1250	G	7204122	6,3
		1655	G	7204162	7,8
Enrørsbjælke		300	G	7022030	1,5
Rørdiameter 48 mm					
Enrørsbjælke		1655	G	8722160	6,0
Med fjederlås		2500	G	8722250	8,8
Rørdiameter 42,4 mm		3050	G	8722300	10,5
Søjleholder		50	G	7208025	2,3
For rørdiameter 50 mm Kan låses med Snapbolt 12 mm					
Søjleholder		34	G	7208018	3,9
For rørdiameter 34 mm Med låseskrue					

			Udfør.	Art. nr	Vægt
Bjælkerytter For rørdiameter 50 mm Kan låses med Snapbolt 12 mm		50	G	7208024	1,2
Bjælkerytter BRS For rørdiameter 34 mm Med låseskrue		BRS-L BRH-L BRL-L	G G G	7208020 7208021 7208022	2,0 2,4 2,5
Bjælkerytter dobbelt For M-hegn eller Længdebjælkear Med låseskrue Nøglevidde 22 mm resp. 21 mm		21 22	G G	7208033 7208031	2,4 2,4
Bøjlegruppe Brille			G	8792000	0,6
Bøjle kobling			G	2048017	1,4
Låseklamme rækværk Nøglevidde 22 mm For rækværk, rørdiameter 38 mm			G	8833000	0,8
Rækværkssøjle SRS Til montage på Længdebjælke		1000	G	7015001	7,3
Rækværkssøjle SS Til montage på Længdebjælke		1000	G	7015000	6,1



			Udfør.	Art. nr	Vægt
Rækværkssøjle Nøglestørrelse 23 mm alt. 22 mm Til montage på enrørsbjælke		23	G	7015005	6,1
		22	G	7015006	6,1
Rækværksbøjle Til montage på længdebjælke			G	7053110	5,5
Dækplade AL ALU-trædeplade Med håndtag og hul for surring Til dækning af hul i indplankningen		995x495x4	AL	4011000	5,2
		1010	AL	7900113	6,5
		1250	AL	7900114	6,5
Beslag til oplukkelig m-hegn Beslaget monteres på rækværk hvorefter et m-hegn føres ind og kan lukke for hul			G	7053001	9,4
Skærmtagskonsol			G	7214066	9,5
Kombinationsjern			G	7205010	2,2

			Udfør.	Art. nr	Vægt
Dækholder		460-2 bd	G	7218023	4,0
Dækholder		230-1 bd	G	7218032	3,0
		460-2 bd	G	7218033	3,5
Fodliste holder			G	7161715	2,3
Hjul Wicke Ø 38 mm Hjuldiameter 250 mm Justerbar 330-630 mm Tilladt belastning 10,0 kN, rullende 4,0 kN		LRG S4	G	2012005	7,4
Støtteben Justerbar		STB 1000	AL	4143101	8,6
BVA BV 10 til omvendt fodspindler og topsøjle BVV 175 til Søjle S		BV 10	G	7155000	3,0
		BVV 175	G	7155131	3,5
Tripod Med lommer på en søjle Rørdiameter 48 mm		500	G	7203340	10,0
		1000	G	7203341	17,3
		1500	G	7203344	23,3
		2000	G	7203342	31,8
		3000	G	7203343	45,8



			Udfør.	Art. nr	Vægt	
Fodspindler 60			G	2071061	15,6	
Adaptor Tripod		60	G	7203312	11,6	
		48	G	7203311	10,0	
Topplader Tripod		Top BVV Tripod	G	7155100	3,0	
		Topplader Tripod	G	7203309	6,3	
Murerbuk			G	7013010	9,2	
Med teleskopisk forlængerrør To stilladsbukke kombineres med en bjælke til en buk		SBT				
Hakitainer		1100	G	7181110	33,6	
		OBS! Ikke godkendt som løfteredskab. Godset skal stroppes til Hakitaineren ved løft med kran	1500	G	7181150	39,4
HAKI Galge		Galgehjul med øje		5211000	3,6	
		HAKI Galgen kombineres med hjul eller HAKI sikkerhedsblok. Kan også anvendes med spil. Kobling med lomme anvendes ved f.eks. stilladsrør 48 mm Tilladt belastning HAKI Galge 200 kg Hjul 70 kg	Kobling m/bøjle	G	7164001	0,9
			G	7173002	7,9	
HAKI Sikkerhedsblok		Tov Ø 18 mm L=30m		2600290	10,0	
		Tilladt last 50 kg	Sikkerhedsblok, HAKI		26150AF	4,5

	Udfør.	Art. nr	Vægt
Stilladsskilt Metal skilt til ophæng på stilladssøjle. Med lomme i A4 til "Fakta om stillads".		2112000	1,1
			
Monteringsværktøj t/M-hegn	AL	4052001	1,4
			
Monteringsværktøj fjederlås		1051001	0,6
			
Stilladsnøgle			
Med spids	21/22 mm	2051022	0,5
Med gaffel	22/23 mm	2051023	0,5
			
Med spids	19/22 mm	2051017	0,5
Med gaffel	19/22 mm	2051015	0,5
Med rund skaft	19/22 mm	2051020	1,0

Søjle

			Udfør.	Art. nr	Vægt
Søjle S4 AL Søjletop med tap Ø 38 mm Rørdiameter 48 mm		S4 500	AL	4017056	1,6
		S4 1000	AL	4017106	2,8
		S4 1500	AL	4017156	4,0
		S4 2000	AL	4017206	5,2
		S4 3000	AL	4017306	7,7
Søjle S4 SC AL		SC 353	AL	4011105	1,0
		SC 853	AL	4011104	2,2
		SC 1353	AL	4011106	3,4
		SC 1853	AL	4011107	4,6
Split til Søjletop Diameter 16 mm Til forstærkning af søjletop ved trækraft f.eks. ved hængende stillads, løft eller stillads til overdækning		Snapbolt Ø16	G	2116000	0,17
		Split med kæde	G	5141257	0,3

Horisontaler

			Udfør.	Art. nr	Vægt
Længdebjælke Med fjederlås Rørdiameter 34 mm		350	AL	4021031	1,9
		700	AL	4021066	2,9
		770	AL	4021073	2,9
		1050	AL	4021101	3,5
		1250	AL	4021121	4,2
		1550	AL	4021151	4,2
		1655	AL	4021161	4,8
		1964	AL	4021191	5,8
		2050	AL	4021201	5,4
		2550	AL	4021247	9,8
Enrørsbjælke Med fjederlås Rørdiameter 48 mm		3050	AL	4021301	8,5
		564	AL	4022051	2,5
		700	AL	4022066	2,7
		770	AL	4022073	2,9
		1010	AL	4022099	3,1
		1050	AL	4022101	3,2
		1250	AL	4022121	3,6
		1550	AL	4022155	3,3
		1655	AL	4022161	4,1
		1964	AL	4022191	4,5
		2050	AL	4022201	4,2
		2500	AL	4022246	7,8
		2550	AL	4022255	5,5
3050	AL	4022301	6,2		

		Udfør.	Art. nr	Vægt
M-hegn Med fjederlås	564	AL	4052051	2,7
	700	AL	4052066	3,3
	770	AL	4052073	3,5
	1010	AL	4052099	4,3
	1050	AL	4052101	4,5
	1250	AL	4052121	4,8
	1550	AL	4052155	5,0
	1655	AL	4052161	5,9
	1964	AL	4052191	6,6
	2050	AL	4052201	6,9
	2500	AL	4052246	5,4
	2550	AL	4052255	8,0
	3050	AL	4052301	8,9



Stag



		Udfør.	Art. nr	Vægt
Diagonalstag Rørdiameter 48 mm	700/770	AL	4122070	4,0
	1250	AL	4122120	4,5
	1655	AL	4122160	4,9
	1964	AL	4122190	5,4
	2050	AL	4112205	5,4
	2500	AL	4122245	6,1
	3050	AL	4122300	6,7
Horisontalstag HDS Rørdiameter 48 mm	HDS 3050x1655 AL L=3468	AL	4141000	7,0
	HDS 3050x1250 AL L=3294	AL	4141001	6,5
	HDS 2500x1655 AL L=2996	AL	4141006	6,3
Horisontalstag teleskopisk HDS Rørdiameter 38-48 mm L=1960-3470 mm Til fag størrelser fra 1655x1050 mm til 3050x1655 mm med 16 faste positioner		AL	4141010	6,3



Konsoller

		Udfør.	Art. nr	Vægt
Konsol Uden søjletop Med fjederlås	SK 230	AL	4211024	1,7
	SK 320	AL	4211033	1,8
	SK 460	AL	4211047	1,9





		Udfør.	Art. nr	Vægt
Konsol med søjletop S4 AL Med søjletop Ø38 mm Rørdiameter Ø48 mm Med fjederlås		SK 564	AL 4211052	3,6
		SK770	AL 4211074	3,9
Konsoldiagonal S4 AL Med søjletop Ø 38 mm Rørdiameter 48 mm Med fjederlås Kombineres med Enrørsbjælke 1250 eller Længdebjælke 1250		SKD S4-1200	AL 4212002	7,8

Øvrige komponenter



		Udfør.	Art. nr	Vægt
Søjleholder S4 AL		AL	4208002	1,7
Bjælkeytter		AL	4208020	1,1



		Udfør.	Art. nr	Vægt	
Fodspindler S6		BS S6-760/515	G	2071032	6,2
Stål					
Ø 34 mm					
Justerbar 55-570 mm					

Søjle

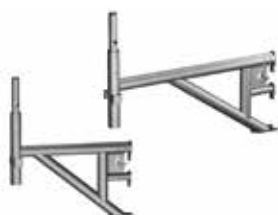





		Udfør.	Art. nr	Vægt	
Søjle S6 AL med snapbolt		S6 500	AL	4018050	2,2
Søjletop med tap Ø 34 mm		S6 1000	AL	4018100	3,7
Rørdiameter Ø 48 mm		S6 1500	AL	4018150	5,3
Inkl. monteret split		S6 2000	AL	4018200	6,8
		S6 3000	AL	4018300	9,9
Søjle S6 AL		S6 500	AL	4018056	2,0
Søjletop med tap Ø 34 mm		S6 1000	AL	4018106	3,5
Rørdiameter Ø 48 mm		S6 1500	AL	4018156	5,1
Uden split		S6 2000	AL	4018206	6,6
		S6 3000	AL	4018306	9,7
Topsøjle S6 AL		SC 353	AL	4018053	1,2
Ø 48		SC 853	AL	4018103	2,8
		SC 1353	AL	4018153	4,3
		SC 1853	AL	4018253	5,8





Konsoller

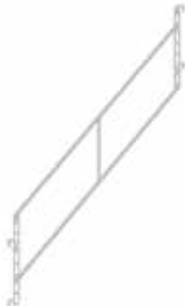





		Udfør.	Art. nr	Vægt	
Konsol med søjletop S6 AL		SK S6-564	AL	4211053	3,9
Med søjletop Ø 34 mm		SK S6-770	AL	4211075	4,2
Rørdiameter 48 mm					
Med fjederlås					
Konsoldiagonal S6 AL		SKD S6-1250	AL	4212001	7,6
Med søjletop Ø 34 mm					
Rørdiameter 48 mm					
Med fjederlås					
Kombineres med Enrørsbjælke 1250 eller Længdebjælke 1250					







			Udfør.	Art. nr	Vægt
<p>Søjleholder S6 AL</p> <p>Med søjletop Ø 34 mm</p> <p>For rørdiameter 34 mm</p>		S6	AL	4208001	1,8
<p>Stilladshjul Wicke S6</p> <p>Ø 34 mm</p> <p>Hjuldiameter 250 mm</p> <p>Justerbar 330-630 mm</p> <p>Tilladt belastning 10,0 kN, rullende 4,0 kN</p>		LRG S6		2012006	7,1

Trappetråd 3050x1655 Symmetriskt

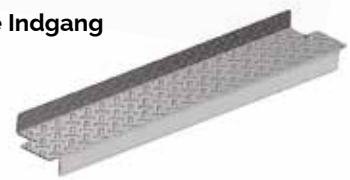



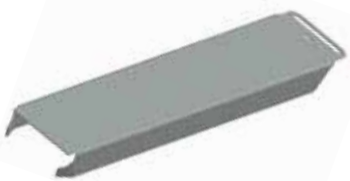

			Udfør.	Art. nr	Vægt
STS Hvileplan			G	7095001	19,2
STS Trappeløb		1000	G	7101120	32,5
		1500	G	7101151	28,6
		2000	G	7101201	33,9
STS Gelænderstolpe Stolpen låses med låsekrog LK 8793000			G	7015102	4,2
STS Gelænderstolpe kil			G	7015104	4,6
STS Gelænder		1000	G	7058104	9,4
		1500	G	7058153	7,5
		2000	G	7058203	8,4
STS Skyddsgrind		SGTS	G	7053002	10,9

			Udfør.	Art. nr	Vægt
STS Fodliste					
Fodliste øvre		780	G	7900029	1,7
Fodliste ALu		1655	AL	4161161	2,9
Fodliste Alu		3050	AL	4161301	5,5
STS Tophegn		SGS	G	7053003	7,6
STS M-hegn		GFL 2210	G	7052222	8,6
		GFL 2357	G	7052232	8,9
STS Adgangstrin		1655	G	7103160	14,7
STS Låsekrog		LK 10x48	G	8793000	0,1

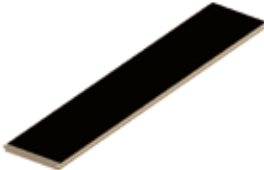
			Udfør.	Art. nr	Vægt
PAS Vangstykke		1655x1000	G	7102100	25,0
		2500x1500	G	7102150	34,5
PAS Gelænder		1655x1000	G	7058100	26,5
		2500x1500	G	7058152	36,5
PAS Gelænder		1655x500	G	7058050	24,0
PAS Hegn		300	G	7053030	7,5
		564	G	7053056	12,1
		700	G	7053070	11,9
		770	G	7053077	12,5
		1100/770-Tripod	G	7053078	11,0
		1100/770-Udbygget	G	7053079	18,5
		1050	G	7053105	15,7
		1250	G	7053125	19,5
		1655	G	7053165	23,0
		1964	G	7053191	28,2
2500	G	7053250	34,2		
PAS Enrørsbjælke m dækplade		1250	G	7104125	6,7
		1250 S	G	7104126	7,2
		1655	G	7104165	8,5
		1655 S	G	7104166	9,2
		1964	G	7104191	10,0
		1964 S	G	7104192	10,7
		2500 S	G	7104257	13,7
PAS Gelænder Indgang		3-trin	G	7058004	15,0
PAS Vangstykke Indgang		3-trin	G	7102006	10,7

		Udfør.	Art. nr	Vægt	
PAS Bundstag Vangstykke		1655	G	7125166	8,1
		2500	G	7125251	11,5
PAS Stålplanke Indgang		1250X270	G	2140121	14,5
		1655x270	G	2140161	20,4
		1964x270	G	2140191	24,2
PAS/HBS Stålplanke Topstykke		1250X250	G	2140122	14,9
		1655x250	G	2140162	19,7
		1964x250	G	2140192	23,4
PAS Stålplanke		1250X300	G	2140123	15,0
		1655x300	G	2140163	23,4
		1964x300	G	2140193	27,0
PAS Gelænder Tripod			G	7058000	7,1
PAS/HBS Stålplanke		1250X200	G	2140125	13,1
		1655x200	G	2140165	17,4
		1964x200	G	2140195	20,6
PAS/HBS Stålplanke		1250X250	G	2140126	14,9
		1655x250	G	2140166	19,7
		1964x250	G	2140196	23,4

		Udfør.	Art. nr	Vægt
HBS Enrørsbjælke med skruelås SBF 	1250	G	7104124	5,3
	1655	G	7104164	6,6
	1964	G	7104194	7,5
	2500	G	7104254	9,1
HBS Planke 	1250x200	G	2140125	13,1
	1250x250	G	2140126	14,9
	2500x200	G	2140255	26,2
	2500x250	G	2140256	29,8
HBS Horisontalstag 	1250x1250	G	7105121	4,4
	2500x1250	G	7105126	8,1
	1250x1655	G	7105161	5,0
	1250x1964	G	7105191	5,7
	2500x1655	G	7105195	7,4
	2500x1964	G	7105197	7,7
	2500x2500	G	7105199	8,7
	1250x2500	G	7105251	6,8
HBS Søjler 	Nederdel	G	7104108	23,6
	Øverdel	G	7104109	21,5
	Mellemdel	G	7104140	16,0
HBS Diagonalstag 	1250	G	7104138	14,8
	2500	G	7104119	17,0
HBS Øvre Bjælke 	1250	G	7104135	10,9
	2500	G	7104118	23,2
HBS Nedre Bjælke 	1250	G	7104136	12,5
	2500	G	7104130	26,8







		Udfør.	Art. nr	Vægt
HBS Beklædningspanel 	250x1250		2033120	2,0
	250x2500		2033250	4,0
	500x1250		2033122	4,0
	500x2500		2033252	8,0
HBS U-Profil Beklædningsprofil 	Venstre	G	7104129	3,5
	Højre	G	7104131	3,5
HBS H-Profil Beklædningsprofil 		G	7104132	7,0
HBS Låseklamme beklædningsprofil 		G	7104133	0,5
HBS Tripod Topadapter inkl. klembeslag 		G	7104111	27,5
HBS Split 	Dorn 20 L=125		2113010	0,3
	Dorn 16 L=90		2113011	0,2
	Dorn 20 L=70		2113012	0,2
	R-Split A-E4	G	6130203	0,02
	Spændskive SRB 21x36x3	G	6130296	0,02
	Spændskive SRB 17,5x34x3	G	6130216	0,01



		Udfør.	Art. nr	Vægt	
AL planke B=200 mm Med drejelås i hver ende L=770-2500 - Lastklasse 6 (6,0 kN/m ²) L=3050 - Lastklasse 5 (4,5 kN/m ²)		770x200x90	AL	2153079	3,6
		1050x200x90	AL	2153105	4,5
		1250x200x90	AL	2153125	5,0
		1655x200x90	AL	2153165	6,2
		1964x200x90	AL	2153195	7,1
		2500x200x90	AL	2153255	8,7
		3050x200x90	AL	2153305	10,3
AL planke B=295 mm Med drejelås i hver ende L=770-1964 - Lastklasse 6 (6,0 kN/m ²) L=2500 - Lastklasse 5 (4,5 kN/m ²) L=3050 - Lastklasse 4 (3,0 kN/m ²)		770x295x90	AL	2153078	4,4
		1050x295x90	AL	2153104	5,4
		1250x295x90	AL	2153124	6,1
		1655x295x90	AL	2153164	7,5
		1964x295x90	AL	2153194	8,6
		2500x295x90	AL	2153254	10,5
		3050x295x90	AL	2153304	12,4
AL planke B=320 mm L=1250-1964 - Lastklasse 6 (6,0 kN/m ²) L=2500 - Lastklasse 5 (4,5 kN/m ²) L=3050 - Lastklasse 4 (3,0 kN/m ²)		770x320x90	AL	2153077	4,7
		1050x320x90	AL	2153103	5,7
		1250x320x90	AL	2153123	6,4
		1655x320x90	AL	2153163	7,9
		1964x320x90	AL	2153193	9,1
		2500x320x90	AL	2153253	11,0
		3050x320x90	AL	2153303	13,1

		Udfør.	Art. nr	Vægt	
Modvægt		Modvægt beton 1500 kg	2121000	1500	
		Spændskiver SRB 21x36x3	G	6130296	0,02
		Skrue M20x140	G	6130350	0,4
		Firkantrør 50x50-650		7156000	4,2
Spindel ledbar Ledbar bundrør L=1200 mm Ø 60 mm Justerbar 176-711 mm Nøglevidde 22 mm		BSLL 1200	G	7153007	19,4
Bøjlegruppe 4x60°		4x60	G	7206000	2,6
Kobling fast Vinkel 30° Nøglevidde 22 mm		KF 34x48 30	G	7164000	1,1
Skilteholderbeslag Til glat skilt med bøjet kant			G	2111000	0,4
Belysningskonsol Nøglevidde 22 mm			G	7213000	1,8

		Udfør.	Art. nr	Vægt
Fodspindler Justerbar 55-570 mm		G	2071000	5,0

Rammer

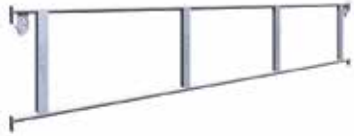
			Udfør.	Art. nr	Vægt
Ramme 2000		RA 2000	G	8731204	17,1
Ramme 1000		RA 1000	G	8731104	12,4
Ramme 800		RA 800	G	8731084	10,0
Ramme 500		RA 500	G	8731053	7,0
Ramme med fodliste		RAF 1000	G	8731105	14,5
L-ramme		RAL 1000	G	8734100	6,1

		Udfør.	Art. nr	Vægt
M-hegn GFL	700	G	7052070	3,8
Med fjederlås	1250	G	7052124	5,7
Rør octagon 28 mm	1655	G	7052164	7,4
	1964	G	7052194	8,1
	2500	G	7052254	9,2
	3050	G	7052304	10,5
M-hegn	SKRDF 700	G	8753000	7,5
Med Fodliste				
				
Endehegn SKRA	SKRA 500-700	G	8751075	4,4
Med kobling			DK	3,5
				

Førankring



		Udfør.	Art. nr	Vægt
Rørfastgørelse	300	G	8832031	1,4
Rørdiameter 48 mm, krok diameter 12 mm	450	G	8832046	2,2
Tilladt belastning 5,4 kN	600	G	8832061	2,6
Monteres med kobling fast 48x48	900	G	8832091	3,7
	1000 ALU	G	8832100	1,4
	1200	G	8832121	4,8
	1500 ALU	G	8832150	2,1

Indplankning

		Udfør.	Art. nr	Vægt
Dæk B=620 mm	PL 700x620	AL	4081077	6,0
Med glasfiber plade	PL 1250x620	AL	4081127	9,5
Lastklasse 3 (2,0 kN/m ²)	PL 1655x620	AL	4081167	11,6
	PL 1964x620	AL	4081197	13,1
	PL 2500x620	AL	4081257	16,6
	PL 3050x620	AL	4081307	18,9
Dæk B=310 mm	PL 1655x310	AL	4082167	7,7
Med glasfiber plade	PL 1964x310	AL	4082197	8,9
Lastklasse 3 (2,0 kN/m ²)	PL 2500x310	AL	4082247	11,3
	PL 3050x310	AL	4082307	13,4
Opgangsdæk	PLLU 1964x620	AL	4081192	14,8
Med glasfiber plade	PLLU 2500x620	AL	4081242	17,4
Lastklasse 3 (2,0 kN/m ²)	PLLU 3050x620	AL	4081303	20,2
				

			Udfør.	Art. nr	Vægt
Alu-lejder St		2100	AL	2091210	3,4
Til alu-dæk med luge PLLU					

Fodlister

			Udfør.	Art. nr	Vægt
Fodliste		FL 3000x150x32		2025300	5,8
Træ, gul		FL 3300x150x32		2025331	5,6
Fodlistebeslag		LFP 150x32		2131001	0,2
Plast/Stål		LF 70 Kort	G	7161012	0,7

Konsoller

			Udfør.	Art. nr	Vægt
Konsol		SK 300	G	8775030	3,9
		SK 700	G	8775070	7,9
		SK 800	G	8775080	9,1





Trapper

			Udfør.	Art. nr	Vægt
UTV Trappe AL		LåsSplit 12 mm	G	2113100	0,1
Med hvileplan og lås		Gelænder HL 2500x2000	AL	4058245	9,2
LxH 3050x2000 mm		Gelænder HL 3050x2000	AL	4058300	10,3
alt. 2500x2000 mm		Trappe UTV 1000	AL	4102100	9,0
Bredde 600 mm		Trappe UTV 2500x2000	AL	4102247	22,9
		Trappe UTV 3050x2000	AL	4102302	29,2
		Gelænderstolpe LSS 1000	G	7015102	4,2
		Beslag LSS-UTV AL	G	7058300	1,5

	Udfør.	Art. nr	Vægt
Melleplade UTV t/rammestillads Til dækning af hullet mellem hvileplan og rammestillads. Kun til UTV Alu 		7211044	3,6

Øvrige komponenter

	Udfør.	Art. nr	Vægt
Ophængningsbjælke 	G	8743700	2,4
Låsebjælke 	G	8744700	2,3
Låsebjælke 	G	8744701	2,3
Tværprofil Nøglevidde 22 mm 	G	8743701	3,7
Bøjle kobling 	G	2048017	1,4
Låseklamme rækværk For rækværk,, rørdiameter 38 mm Nøglevidde 22 mm 	G	8833000	0,8
Låsekrog Til låsning af søjletop ved belastning Til f.eks. ved løft eller ved overdækning Ikke for hængende stilladser 	G	8793000	0,1
Gennemgangsramme Med 2 faste og 2 skjulbare søjletapper Fag bredde 1460 mm 	G	8732201	39,5
Ramtainer Til 20 stk. stående rammer Rammerne surres til ramtaineren med spændebånd 	G	8871000	28,9

			Udfør.	Art. nr	Vægt
Ramme 2000 AL		RA 2000	AL	4731201	8,9
Ramme 1000 AL		RA 1000	AL	4731101	6,4
Ramme 800 AL		RA 800	AL	4731081	5,1
Ramme 500 AL		RA 500	AL	4731051	3,8
Ramme med fodliste		RAF 1000	AL	4731105	7,7





Rækværk







			Udfør.	Art. nr	Vægt
M-hegn AL Med fjederlås		SKRD 1250	AL	4052121	4,8
		SKRD 1655	AL	4052161	5,9
		SKRD 1964	AL	4052191	6,6
		SKRD 2500	AL	4052246	7,8
		SKRD 3050	AL	4052301	8,9

		Udfør.	Art. nr	Vægt
Konsol AL				
Konsol SK 700 med og		AL	4211072	3,5
konsol SK 650 uden søjletop		AL	4211073	3,0
Nøglevidde 22 mm				

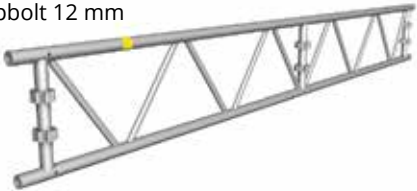
		Udfør.	Art. nr	Vægt
Stilladsrør 	SR 48-1000	G	7241100	4,1
	SR 48-1500	G	7241150	6,1
	SR 48-2000	G	7241200	8,0
	SR 48-2500	G	7241250	10,3
	SR 48-3000	G	7241300	12,4
	SR 48-3500	G	7241350	14,1
	SR 48-4000	G	7241400	16,7
	SR 48-4500	G	7241450	18,0
	SR 48-5000	G	7241500	20,1
SR 48-6000	G	7241600	24,1	

Rørkoblinger

		Udfør.	Art. nr	Vægt
Kobling fast Nøglevidde 22 och 23 mm 	RA 48x48 22	G	2048010	1,2
	RA 48x48 23	G	2048012	1,2
Kobling dreje Nøglevidde 22 och 23 mm 	SW 48x48 22	G	2048011	1,4
	SW 48x48 23	G	2048013	1,4
Diverse koblinger 	Bjælkekobling SK 48 1-19		2044000	1,3
	Rørsamler 48		2045001	1,3
Stilladsnøgle Med skralde 	21/22 mm		2051022	0,5
	22/23 mm		2051023	0,5
Adapter For kobling 48 mm på 34 mm rør 	35		2041001	0,03

		Udfør.	Art. nr	Vægt
450 Alu-drager m/bøjler	2220	AL	4032211	9,9
Med bøjler vertikalt og hul i det øverste rør til kedergaffel	4100	AL	4032411	17,8
Drageren samles med 2 stk.7203000 Samlepind og	6100	AL	4032611	25,8
8 stk. Snapbolt 12 mm	8100	AL	4032811	34,0
				
450 Alu-drager	4100	AL	4032410	16,7
Alu-drager samles med 2 stk. 7203000 Samlepind og	6100	AL	4032610	24,3
8 stk. Snapbolt 12 mm	8100	AL	4032810	32,2
				
450 Kipbeslag	Samlepinde	G	7203000	2,0
Kipbeslag skal monteres med 4 stk.	30 gr. nedre	G	7203003	2,8
snabbolt 12 mm	30 gr. øvre	G	7203004	5,7
	15 gr. nedre	G	7203005	2,3
	15 gr. øvre	G	7203008	4,0
	22,5 gr. øvre	G	7203013	4,2
	22,5 gr. nedre	G	7201316	2,6
				
450 Sternbeslag	37,5 gr.	G	7201313	2,6
Samlepind skal monteres med	22,5 gr.	G	7201315	2,9
snabbolt 12 mm	37,5 gr. ydre	G	7203012	5,1
	22,5 gr. øvre	G	7203014	3,9
				
Enrørsbjælke	2500	G	8722250	8,8
Med fjederlås	3050	G	8722300	10,5
Rørdiameter 42 mm				
				
450 Rækværksholder		G	7014000	3,8
				

Udfør.	Art. nr	Vægt
--------	---------	------

450 Vægstolpe

For drager 450 AL







Monteres med 4 stk. snapbolt 12 mm



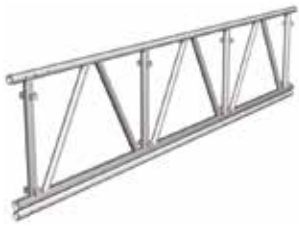

G



7014010





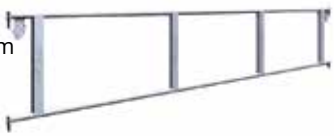



12,7











			Udfør.	Art. nr	Vægt
750 Alu-drage		1250	AL	4032125	9,4
		2250	AL	4032225	16,6
		3250	AL	4032325	23,9
		6250	AL	4032625	46,0
750 Alu-drager Kip		15°	AL	4202260	18,3
		22,5°	AL	4202261	17,6
		37,5°	AL	4202267	16,6
750 Samlepind			G	7203001	2,0
Snapbolt Diameter 12 mm resp. 16 mm		Snapbolt Ø12	G	2113100	0,1
		Snapbolt rørsplit Ø16	G	2116000	0,2
Dorn		HCB-bult 12x80	G	6130049	0,08
		R-Split	G	6130441	0,01
750 Diagonalstag Rørdiameter 53 mm OBS! Normal rørbkobling 48 mm kan ikk kobles til røret		1250x1000	AL	4122119	1,0
		1250x1250	AL	4122121	2,7
		1250x2000	AL	4122123	4,0
		1250x2250	AL	4122124	4,0
		1655x1000	AL	4122159	3,0
		1655x1250	AL	4122162	3,4
		1655x2000	AL	4122163	3,3
		1655x2250	AL	4122164	4,0
		1964x1000	AL	4122191	0,0
		1964x1250	AL	4122192	3,7
		1964x2000	AL	4122193	4,3
		1964x2250	AL	4122194	4,6
		2500x1000	AL	4122248	1,6
		2500x1250	AL	4122249	4,4
		2500x2250	AL	4122253	5,1
		2500x2000	AL	4122254	4,9
3050x1000	AL	4122298	1,8		
3050x1250	AL	4122299	5,0		
3050x2000	AL	4122303	5,5		
3050x2250	AL	4122304	5,6		



		Udfør.	Art. nr	Vægt
750 Rækværkssøjle		G	7203322	10,5
750 Kobling dreje SW		vert. 48	G 2048007	1,8
Nøglevidde 22 mm Til specialprofilen på Alu-drager 750 AL		hor. 48	G 2048008	1,8
750 Drager-adapter komplet			G 7203335	16,8
Inkl. . 2 stk. klembeslag Stillbar i 12-22° samt 0°				
750 Drager-adapter komplet m/bøjler			G 7203336	22,5
Inkl. . 2 stk. klembeslag Stillbar i 12-22° samt 0°				
750 Fodbeslag Y-model		G	7203320	10,4
750 Hjul til trekantdrager		G	7142003	9,9
750 Antiløft konsol f/hjul og trekantdrager komplet			G 7175059	3,1
Ekskl. 2 stk. M12x40 skrue og møtrik				
U-bjælke til antiløftkonsol		3000	G 7175060	16,0
Ekskl. 7 stk. resp. 5 stk. M14x30 skruer og møtrikker		2000	G 7175061	10,6

		Udfør.	Art. nr	Vægt
750 Trekant-drager Rørdiameter 48 mm		2000	G 7203332	31,7
		3000	G 7203333	44,0
750 Kobling Spor komplet		Øvre del	G 2044100	1,3
		Underdel	G 2044101	0,6
Spændebånd		10 m 4000 kg	2051601	2,5
750 Presenning Trækrulle Til montering af presenning		1250	G 7500011	7,8
		1655	G 7500025	9,4
		1964	G 7500017	10,6
		2500	G 7500009	12,6
		3050	G 7500008	14,8
750 Presenning Endeholder		1250	G 7500013	5,9
		1655	G 7500027	7,6
		1964	G 7500040	7,0
		2500	G 7500014	10,6
		3050	G 7500015	12,9
750 Holderør t/presenning		1250	G 7500024	4,3
		1655	G 7500028	5,9
		1964	G 7500042	5,6
		2500	G 7500023	9,2
		3050	G 7500022	11,3
750 Kiphegn med rulle		1250	G 7500018	11,2
		1655	G 7500019	13,9
		1964	G 7500041	16,0
		2500	G 7500020	17,9
		3050	G 7500021	20,5
M-hegn GFL Med fjederlås Rør octagon 28 mm		1250	G 7052124	5,7
		1655	G 7052164	7,4
		1964	G 7052194	8,1
		2500	G 7052254	9,2
		3050	G 7052304	10,5

		Udfør.	Art. nr	Vægt
750 Skinne for kip	15°	G	7541015	2,8
Taghældning 15°, 22,5° alt. 37,5°	22,5°	G	7541022	2,8
Uden monteret 7540001	37,5°	G	7541037	3,0
Samlepind AL				
Mærket med art. nr. i ene ende				
				
750 Skinne	1250	G	7541125	2,6
L=1250, 2250, 3250 og 6250 mm	2250	G	7541225	4,7
Med 7540001 Samlepind AL	3250	G	7541325	6,7
monteret i øverste ende	6250	G	7541625	12,9
Mærket med art. nr. i øverste ende				
				
750 Skinne takfot	15°	G	7541150	3,3
Tagvinkel 15°, 22,5° alt. 37,5°	22,5°	G	7541220	3,3
Med 7540001 Samlepind AL	37,5°		7541370	3,3
monteret i øverste ende				
Mærket med art. nr. i øverste ende				
				
750 Trak Faldsikrings beslag		G	7541006	7,6
				
750 Faldsikringsbeslag	15°	G	7541007	10,4
Til HAKITEC 750 med HAKI Trak	22,5°	G	7541008	10,4
Med skinne for kip taghældning				
15° alt. 22,5°				
				
750 Presenning Montage Rullebeslag		G	7500010	7,4
Til montering af presenning				
				

		Udfør.	Art. nr	Vægt
750 Laskeplade		G	7540000	0,2
750 Samlepinde		AL	7540001	0,04
750 Pakning			7540002	0,1
750 Spændebånd			7540003	0,5
			3 m 450 kg	
750 Kedergaffel		G	7541000	0,5
Monteres till Drager 750 AL med 1 st 2113100 Snapbolt 12 mm OBS! 2113000 Snapbolt 12 mm anbefales ikke til denne komponent				
750 Keder Endebeslag		G	7541002	1,3
Monteres til Drager 750 AL med 1 st 2113100 Snapbolt 12 mm OBS! 2113000 Snapbolt 12 mm anbefales ikke til denne komponent				
Stilladsnøgle			2051019	0,3
Med gaffel			2051021	0,3
		19		
		22		
Keder kobling		G	2048030	1,0
Nøglevidde 22 mm				
Styrerulle Trak presenning		G	7541005	1,1
Til montering af presenning				

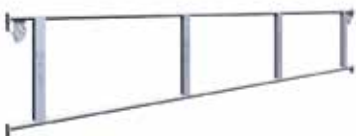
			Udfør.	Art. nr	Vægt
TKS 750 Alu-drager		1250	AL	7570125	12,2
Samles med 2 stk samlepinde		2250	AL	7570225	21,2
og 4 dørne/møtrikker		3250	AL	7570325	31,2
pr. drage					
TKS 750 Kip-drager		15,0°	AL	7570015	23,2
		22,5°	AL	7570025	19,6
		37,5°	AL	7570035	21,9
TKS 750 Ende keder		0,62 m		7570005	2,2
TKS 750 Presenning trækrulle 1 sæt				7570004	8,6
TKS 750 Drage-adapter				7570006	12,2
TKS 750 Beslag f.Adapter				7570007	4,7
Anvendes til 7570006					
OBS 2 stk. klembeslag					
TKS 750 Klembeslag f. Adapter				5231618	1,3
TKS 750 Pakning				7570001	0,1
750 Samlepind				7203001	2,0
OBS Møtrik 6130588 og					
bolt 6130587					
Snapbolt		snapbolt ø12	G	2113100	0,1
Diameter 12 mm resp. 16 mm		snapbolt ø16	G	2116000	0,2
Dorn		Dorn 12x80	G	6130049	0,08
		R-Sprint	G	6130441	0,01
		Øjemøtrik		7570003	0,20

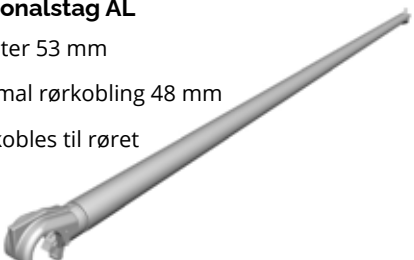
		Udfør.	Art. nr	Vægt
M-hegn GFL- Fzv	2500	G	7052254	9,2
Med fjederlås	3050	G	7052304	10,3
				
TKS 750 Rækværk- Fzv	3050	G	7056301	7,1
Med fjederlås	2500	G	7056246	6,0
				
750 Diagonalstag AL	2500x2250	AL	4122253	5,1
Rørdiameter 53 mm	2500x2000	AL	4122254	4,9
OBS! Normal rørkobling 48 mm	3050x2000	AL	4122303	5,5
kan ikke kobles til røret	3050x2250	AL	4122304	5,6
				
TKS DUG				
Farve på slag HAKI standard				
L= 8000 Grå	8000x3050		2800300	9,3
L=10000 Hvid	10000x3050		2800301	11,6
L=12000 Rød	12000x3050		2800302	13,9
L=14000 Blå	14000x3050		2800303	16,2
	8000x2500		2800359	13,6
	10000x2500		2800360	17,0
	12000x2500		2800361	20,4
	14000x2500		2800362	23,8
Spænderem				
2m - 400 kg.			7500050	0,1

HAKI Trak dug

PVC belagt polyesterhvæv
Med kederliste
Producers efter ordre i
ønskede bredde og længde



Efter tilbud

HAKI Trak gavldug

Med kederliste på en side
Bredde 935 mm
OBS! Dækker kun drager



Efter tilbud

HAKITEC presenning
HAKITEC tagplast

Armered plastdug, 250 g/m²
Levereres på rulle



3,3-36 m

2500300

38,0

Plastik brandhæmmende

220 g/m²
Levereres på rulle



4,0-36 m

2092436

36,0

3,2-40 m

2092336

28,8

Fasade plastik

Armered plastdug,, 170 g/m²
Levereres på rulle

4,0-36 m

2092400

21,6

3,2-36 m

2092320

17,3

2,2-36 m

2092220

11,9

Stilladsnet

Stormasket, Leveres på rulle

3,2-100 m

2092001

12,3

Finmasket 90% vindreduktion 125 gr/m²

3,2-50m

2092050

20,0

Finmasket 90% vindreduktion /brandhæm/125 gr/m²

3,2-50m

2092051





23,2

Sort stilladsnet



3,0-50m

2092490

25,0

		Udfør.	Art. nr	Vægt
Stropper			2032300	0,01
Beregn en strop per 1,5 m ²				
I pakker af 100 stk				
Sømbjælke		950 23	7207095	5,0
Nøglevidde 23 mm resp. 22 mm		950 22	7207096	5,0
		1900 23	7207190	8,0
		1900 22	7207191	8,0
Tagplader HAKITEC		Tagskinne skrue BTL 4,8x35	2114000	0,01
Beregn 6 stk tagskinneskrue		Tagskinne 1900	G 7251200	3,3
pr.tagskinne, samt 2 stk kipskinne		Tagskinne f/kip 15	G 7252001	0,8
Skruer leveres 250/pakke				
Faldsikringsbeslag			7541010	10,0
Til HAKITEC 750 med HAKITEC dug				
Med taghældning 15°				

Stilladstag

		Udfør.	Art. nr	Vægt
Tagbøjler		Tagbøjle	G 7014001	18,0
Tagbøjle = fagbredde 700-770 mm		Forlænger t/tagbøjle	G 7014002	3,5
Tagbøjle + 1 stk. Forlængerrør = fagbredde 1050-1250 mm				
Tagbøjle + 2 stk. Forlængerrør = fagbredde 1655 mm				
Som afstand mellem tagbøjlerne anvendes M-hegn eller Længdebjælke				
Tagbøjle stilladstag		G	7014003	7,0
For montage direkte på en søjle top				
Som forlænger anvendes en søjle, maximalt søjle S 1000				

ØVRIGT SORTIMENT



			Udfør.	Art. nr	Vægt
Dørskinne AL		1250	AL	4023120	4,1
		1655	AL	4023160	5,2
		1964	AL	4023190	6,0
		2500	AL	4023250	7,5
		3050	AL	4023300	9,0

Tribune

			Udfør.	Art. nr	Vægt
Konsol					
B= 460 mm Til montage på enrørsbjælke ERB		G	7211002	3,4	
Sidehegn			G	7053100	15,0

Safety

			Udfør.	Art. nr	Vægt
Universal tvinge			G	7155141	8,1
Skruefod			G	7155140	1,6

	Udfør.	Art. nr	Vægt
<p>Netskærmsholder SGF Til netskærm SGF Gør det muligt at placere næste søjle på søjle på valgfri afstand og i valgfri retning $\pm 45^\circ$</p> 		7053108	4,3
<p>Rækværksholder GFL Til M-hegn GFL Gør det muligt at placere næste søjle på valgfri afstand og i valgfri retning $\pm 45^\circ$</p> 		7053109	1,8
<p>Klembeslag 500 Nøglevidde 30 mm Monteres på pladekanten, tykkelse 15-35 mm</p> 	G	7215032	5,5

		Udfør.	Art. nr	Vægt
Vippehegn til materialehegn				
	3050		7059170	150,0
	2500		7059250	140,0
				
Haki Easy topmonteret el-talje 23 m wire	80 kg.		2601001	9,0
Haki Easy bundmonteret el-talje 40 m wire Svingarm	60 kg.		2601002	15,0
			G005711	11,5
				
Kasseskærm af genbrugsplast - sort	110x115 cm		2021408	8,3

Registrer

450 Alu-drager	10
450 Alu-drager	39
450 Alu-drager m. bøjler	10
450 Alu-drager m/bøjler	39
450 Kipbjælke med rulle	40
450 Ophængningsbeslag LB	58
450 Rækværksholder	39
450 Samlepind	39
450 Skinne	40
450 Skinnefastgørelse tagfod	40
450 Sternbeslag	39
450 Vægstolpe	40
750 Alu-drage	10
750 Alu-drage	41
750 Alu-drager Kip	41
750 Antiløft konsol f/hjul og trekantdrager komplet	42
750 Diagonalstag	41
750 Drager-adapter/fodbeslag	59
750 Drager-adapter komplet	42
750 Drager stål	52
750 Faldsikringsbeslag	44
750 Fodbeslag Y-model	42
750 Hjul til trekantdrager	42
750 Holderør t/presenning	43
750 Keder Endebeslag	45
750 Kedergaffel	45
750 Kiphegn	47
750 Kiphegn med rulle	43
750 Kobling dreje SW	42
750 Kobling Spor komplet	43
750 Laskeplade	45
750 Midterstykke stål	52
750 Pakning	45
750 Presenning Endeholder	43
750 Presenning Montage Rullebeslag	44
750 Presenning Trækrulle	43
750 Rækværkssøjle	42
750 Samlepind	41
750 Samlepinde	45
750 Skinne	44
750 Skinne for kip	44
750 Skinne takfot	44
750 Spændebånd	45
750 Trak Faldsikrings beslag	44
750 Trekant-drager	43
Adapter Alu-drager	10

Adapter Alu-drager	52
Adaptor	38
Adaptor Tripod	17
Adgangstrin	11
AL plank B=200 mm	30
AL plank B=230 mm	7
AL plank B=230 mm	50
AL plank B=295 mm	30
AL plank B=320 mm	30
Alu-lejder St	7
Alu-lejder St	34
Belysningskonsol	31
Beslag til oplukkelig m-hegn	15
Bjælkeytter	14
Bjælkeytter	21
Bjælkeytter	53
Bjælkeytter BRS	14
Bjælkeytter dobbelt	14
Briller	14
Briller	35
BVA	16
Bøjlegruppe	31
Diagonalstag	20
Diagonalstag DS	5
Diagonalstag udbygget for Trallee	5
Diverse koblinger	38
Dorn	41
Dæk B=310 mm	33
Dæk B=620 mm	33
Dækholder	16
Dækholder	16
Dækplade AL	15
Dørskinne AL	54
Endehegn SKRA	33
Enrørsbjælke	4
Enrørsbjælke	13
Enrørsbjælke	13
Enrørsbjælke	19
Enrørsbjælke	39
Enrørsbjælke	49
Enrørsbjælke	53
Enrørsbjælke	54
Faldsikringsbeslag	47
Fasad Light 170	46
Fasadväv 50	46
Fodliste	8
Fodliste	34

Fodliste	51
Fodlistebeslag	8
Fodlistebeslag	8
Fodlistebeslag	8
Fodlistebeslag	34
Fodlistebeslag	51
Fodlistebeslag AL	51
Fodliste holder	16
Fodspindeltop	53
Fodspindler	3
Fodspindler	32
Fodspindler 60	17
Fodspindler led- og vippebar 750	3
Fodspindler S6	22
Forstærkningsbeslag t/tag	40
Gennemgangsramme	35
HAKI Galge	17
HAKI Sikkerhedsblok	17
HAKI Stålp plank B=230 mm	7
HAKI Stålp plank B=230 mm	50
Hakitainer	17
HAKITEC	46
HAKITEC flamhæmmende	46
HAKI Trak dug	46
HAKI Trak gavldug	46
HBS Beklædningspanel	29
HBS Diagonalstag	28
HBS Enrørsbjælke med skruvlås SBF	28
HBS Horisontalstag	28
HBS H-Profil Beklædningsprofil	29
HBS Låseklamme beklædningsprofil	29
HBS Nedre Bjælke	28
HBS Planke	28
HBS Split	29
HBS Søjler	28
HBS Tripod Topadapter inkl. klembeslag	29
HBS U-Profil Beklædningsprofil	29
HBS Øvre Bjælke	28
Hjul	16
Hjul til tag	58
Horisontalstag HDS	5
Horisontalstag HDS	20
Horisontalstag teleskopisk HDS	20
Hvileplan VLP	55
Hylsnyckel	38
Højdeindstillingsbeslag	53
Højdeindstillingssøjle	13

Keder kobling	45
Klembeslag 500	58
Kobling dreje	38
Kobling fast	31
Kobling fast	38
Kombibjælke	49
Kombi fodbræt	8
Kombikonsol	51
Kombinationsjern	15
Kombinationsjern	15
Konsol	9
Konsol	20
Konsol	34
Konsol AL	37
Konsoldiagonal	9
Konsoldiagonal S4 AL	21
Konsoldiagonal S6 AL	22
Konsol justerbar	9
Konsol med søjletop	9
Konsol med søjletop S4 AL	21
Konsol med søjletop S6 AL	22
Konsol uden søjletop	9
Krogdæk B=400 mm	6
Krogdæk B=400 mm	50
Krogdæk B=600 mm	6
Krogdæk B=600 mm	50
Krogdæk med lucka B=600 mm	7
Krogdæk med lucka B=600 mm	50
Krogdæk med lucka og Stige	7
Krogdæk med låge og stige	50
L-ramme	32
LT Diagonal	18
Låsbeslag traller	53
Låsebeslag til hjul	58
Låsebjælke	35
Låsefjeder til fodspindel	3
Låseklamme rækværk	14
Låseklamme rækværk	35
Låsekrog	35
Længdebjælke	3
Længdebjælke	19
Længdebjælke	49
Længdebjælke	54
Mellemlade UTV t/rammestillads	35
M-hegn	20
M-hegn	33
M-hegn	54

M-hegn AL	36
M-hegn For træTralle GFLH	4
M-hegn GFL	4
M-hegn GFL	33
M-hegn GFL	43
M-hegn GFL	49
M-hegn GFLH	49
Modvægt	31
Monteringsværktøj fjederlås	18
Monteringsværktøj Hængende stillads	53
Monteringsværktøj t/M-hegn	18
Murerbuk	17
Netskærm SGF	4
Netskærm SGF	49
Netskærmsholder SGF	58
Opgangsdæk	33
Ophængningsbjælke	35
PAS Bundstag Vangstykke	27
PAS Enrørsbjælke m dækplade	26
PAS Gelænder	26
PAS Gelænder	26
PAS Gelænder Indgang	26
PAS Gelænder Tripod	27
PAS/HBS Stålpånke	27
PAS/HBS Stålpånke	27
PAS/HBS Stålpånke Topstykke	27
PAS Hegn	26
PAS Stålpånke	27
PAS Stålpånke Indgang	27
PAS Vangstykke	26
PAS Vangstykke Indgang	26
Portdrager	10
Ramme 500	32
Ramme 500 AL	36
Ramme 800	32
Ramme 800 AL	36
Ramme 1000	32
Ramme 1000 AL	36
Ramme 2000	32
Ramme 2000 AL	36
Ramme med fodliste	32
Ramme med fodliste	36
Ramtainer	35
Ringnyckel	45
Rækværksbøjle	15
Rækværksholder GFL	58
Rækværkssøjle	13

Rækværkssøjle	15
Rækværkssøjle SRS	14
Rækværkssøjle SS	14
Rørfastgørelse	33
Rørfastgørelse	33
Rørfastgørelse SVF	5
Rørfastgørelse SVF	5
Sidehegn	57
Skilteholderbeslag	31
Skruebeslag	57
Skærmtagskonsol	15
Snapbolt	41
Sparkplade	57
Spindel ledbar	31
Spindel ledbar	53
Split til Søjletop	3
Split til Søjletop	19
Spændebånd	43
SS Klembeslag	12
SS Montagestag	12
SS Ophængningsbeslag Bulb-profil	52
SS Ophængningsbeslag Bulb-profil	52
SS Ophængningsbeslag Bulb-Rør	52
SS Ophængningsbeslag Gridgulv	12
SS Ophængningsbeslag H-profil	12
SS Ophængningsbeslag KF 48 dobbelt	12
SS Ophængningsbeslag Kæder	12
SS Ophængningsbeslag L-profil	12
Start Søjle	40
STC Adgangstrin	56
STC Fodliste	56
STC Gelænder komplet	56
STC Hvileplan	55
STC Indgangsbjælke	56
STC M-Hegn foldbar	56
STC Top Gelænder	56
STC Trappeløb	55
Stilladshjul S6	23
Stilladsnøgle	18
Stilladsnøgle	38
Stilladsrør	38
Stilladsskilt	18
Stolesektion	57
Stropper	47
STS Adgangstrin	25
STS Fodliste	25
STS Gelænder	24

STS Gelænderstolpe	24
STS Gelænderstolpe	55
STS Gelænderstolpe kil	24
STS Hvileplan	24
STS Låsekrog	25
STS M-hegn	25
STS Skyddsgrind	24
STS Tophegn	25
STS Trappeløb	24
StV Stige med hvileplan	11
Styrerulle Trak presenning	45
Støtteben	16
Søjleholder	13
Søjleholder	13
Søjleholder S4 AL	21
Søjleholder S6 AL	23
Søjle S	3
Søjle S4 AL	19
Søjle S6 AL	22
Søjle S6 AL med snapbolt	22
Sømbjælke	47
Tagbøjler	47
Tagbøjle stilladstag	47
Tagplader HAKITEC	47
Tang HAKITEC	47
Top-hegn SGT FZV T/Trappe	55
Topplader Tripod	17
ToppSøjle SC	3
Tralle AL	6
Tralle ERGO Træ	6
Tralle Komposit	6
Tralle Stål	6
Trappeløb TRP	55
Tribunekonsol	57
Tripod	16
Tværprofil	35
U-bjælke til antiløftkonsol	42
Understøtningsbjælke	13
Understøtningsbjælke	53
Universalfastgørelse	57
UTV Gelænder indv.	11
UTV Trappe	11
UTV Trappe	34
UTV Trappe AL	11
UTV Trappe AL	11
UTV Trappe AL	34
Vægstag VSt	5

